

Infrared Receiver Control Receiver Module IRM-H600JW/TR2

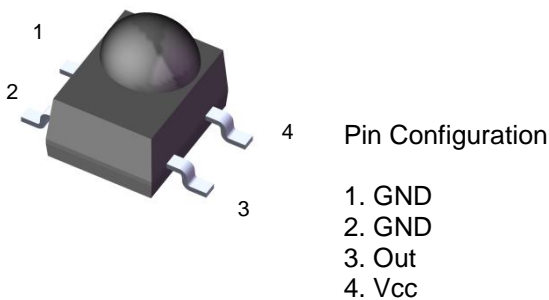

Block Diagram

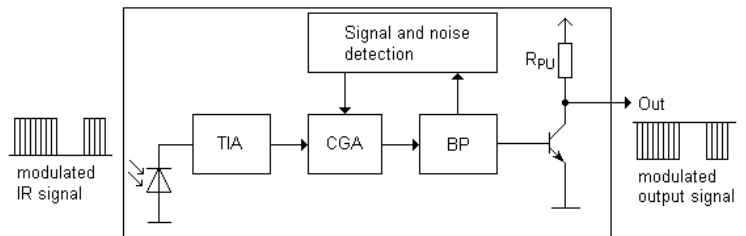

Features

- High protection ability against EMI
- Circular lens for improved reception characteristics
- Available for Carrier Frequencies between 20KHz to 60KHz
- TTL and CMOS Compatible
- Low operating voltage (V_{cc} = 2.7V)
- High immunity against ambient light
- Long reception range
- High sensitivity
- Pb free and RoHS compliant

Description

The IRM-H600JW devices are miniature type infrared receivers which have been developed and designed by using the latest IC technology.

The photo diode and preamplifier are assembled onto a lead frame and molded into an epoxy package which operates as an IR filter.

The receiver provides a modulated output signal which can be used for IR code learning and IR repeater.

Applications

- IR code learning
- IR repeater
- Remote control

Application Circuit

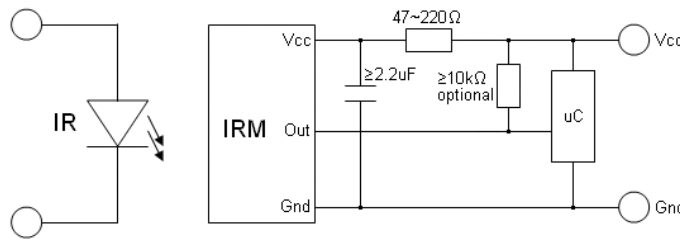

Parts Table

| Model No. | Carrier Frequency |
|---------------|-------------------|
| IRM-H600T/TR2 | 20~60 kHz |

Absolute Maximum Ratings (Ta=25°C)

| Parameter | Symbol | Rating | Unit |
|-------------------------------------|--------|-----------|------|
| Supply Voltage | Vcc | 6 | V |
| Operating Temperature | Topr | -20 ~ +85 | °C |
| Storage Temperature | Tstg | -40 ~ +85 | °C |
| Soldering Temperature ^{*1} | Tsol | 260 | °C |

^{*1} 4mm from mold body for less than 10 seconds

Electro-Optical Characteristics (Ta=25°C)

| Parameter | Symbol | Min. | Typ. | Max. | Unit | Condition |
|---------------------------|-----------------|----------------------|------|------|------|---|
| Current consumption | I _{CC} | --- | 0.4 | 0.5 | mA | No input signal |
| Supply voltage | V _{CC} | 2.7 | - | 5.5 | V | |
| Reception range | L ₀ | 8 | --- | --- | m | See chapter 'Test method' |
| | L ₄₅ | 5 | --- | --- | m | |
| Half angle(horizontal) | φ _h | --- | ±45 | --- | deg | Test signal according to figure 1 |
| Half angle(vertical) | φ _v | --- | ±45 | --- | deg | |
| High level output voltage | V _{OH} | V _{CC} -0.4 | --- | --- | V | |
| Low level output voltage | V _{OL} | --- | 0.2 | 0.5 | V | I _{SINK} ≤ 2mA |
| Internal pull up resistor | R _{PU} | 46 | 52 | 58 | kΩ | |

Test method

The specified electro-optical characteristics are valid under the following conditions.

1. Measurement environment

A place without extreme light reflections.

2. External light

The environment contains an ordinary, white fluorescent lamp without high frequency modulation. The color temperature is 2856K and the illumination at the IR receiver is less than 10 Lux ($E_v \leq 10\text{Lux}$).

3. Standard transmitter

The test transmitter is calibrated by using the circuit shown in figure 2. The radiation intensity of the transmitter is adjusted until $V_o=400\text{mVp-p}$. Both, the test transmitter and the photo diode, have a peak wavelength of 940nm.

The photo diode for calibration is PD438B ($\lambda_p=940\text{nm}$, $V_r=5\text{V}$).

4. The measurement system is shown in Fig.-3

Fig.-1 Transmitter Wave Form

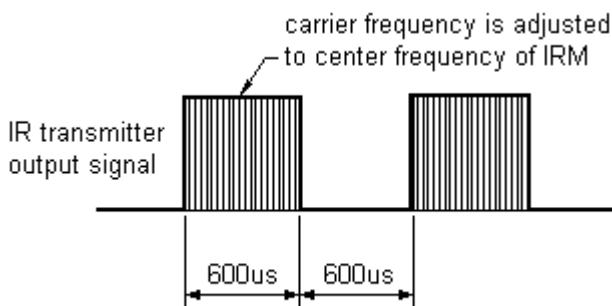

D.U.T output Pulse

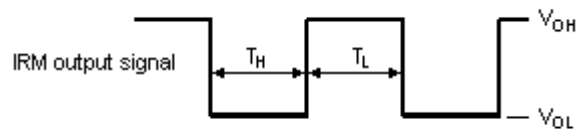
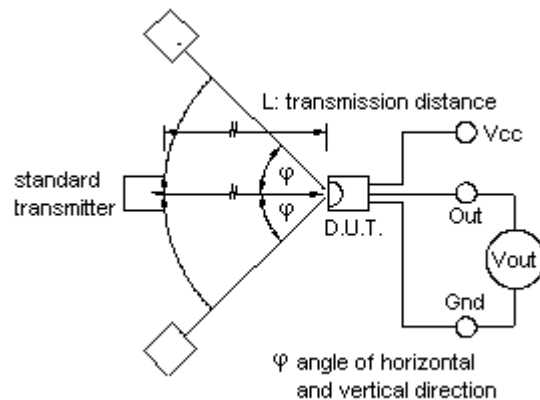
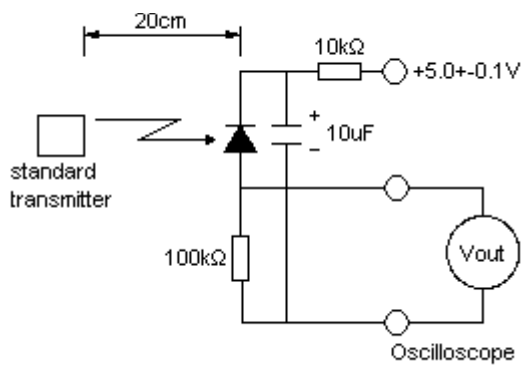

Fig.-3 Measuring System



Typical Electro-Optical Characteristics Curves

Fig.-4 Relative Responsibility vs. Wavelength

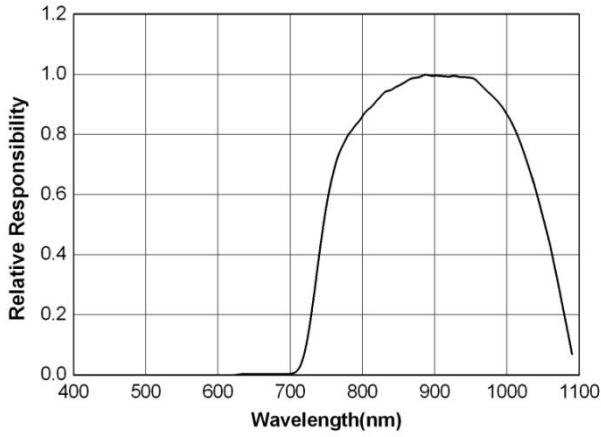

Fig.-5 Relative Sensitivity vs. Horizontal Angle

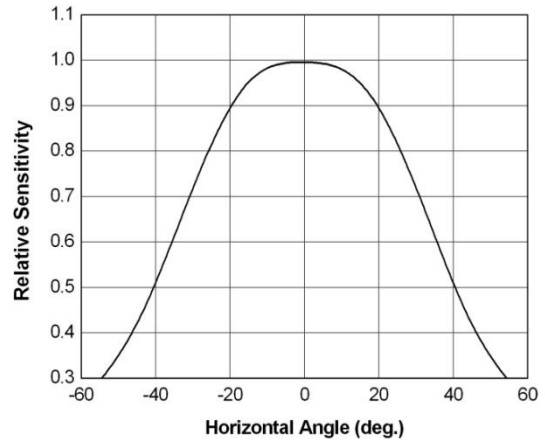

Fig.-6 Relative Transmission Distance vs. Supply Voltage

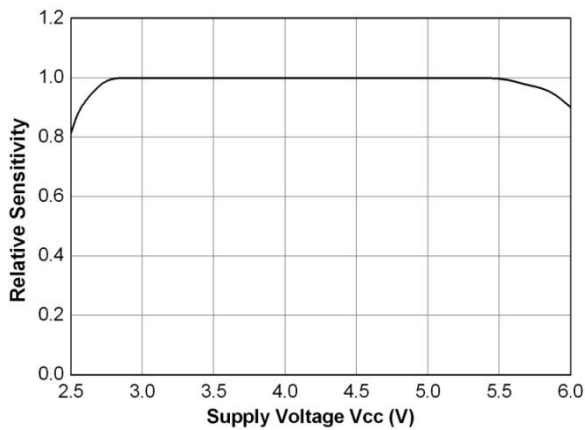
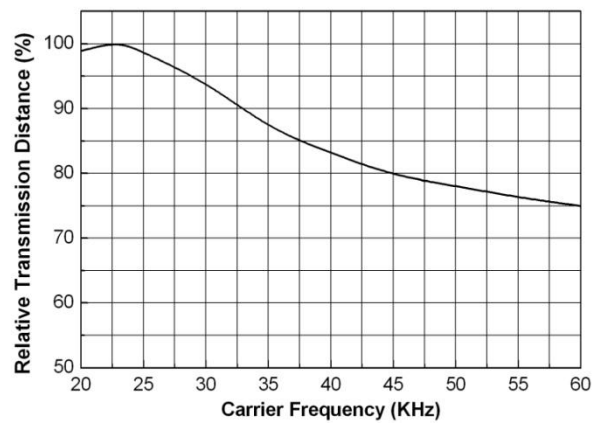
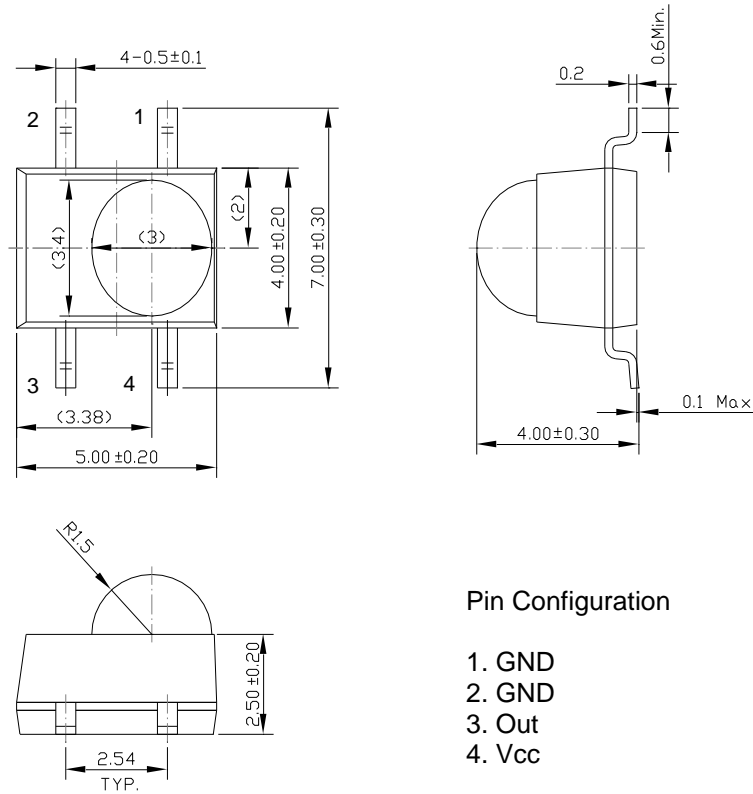

Fig.-7 Relative Transmission Distance vs. Carrier Frequency



Package Dimension



Pin Configuration

- 1. GND
- 2. GND
- 3. Out
- 4. Vcc

(Dimensions in mm)

Notes:

Tolerance unless otherwise mentioned ± 0.3 mm

Recommended pad layout for surface mount leadform

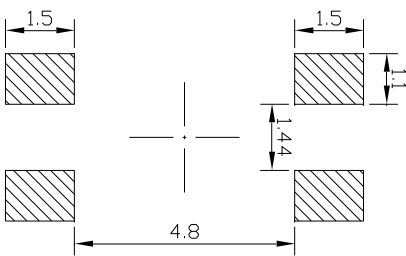

Tape & Reel Packing Specifications

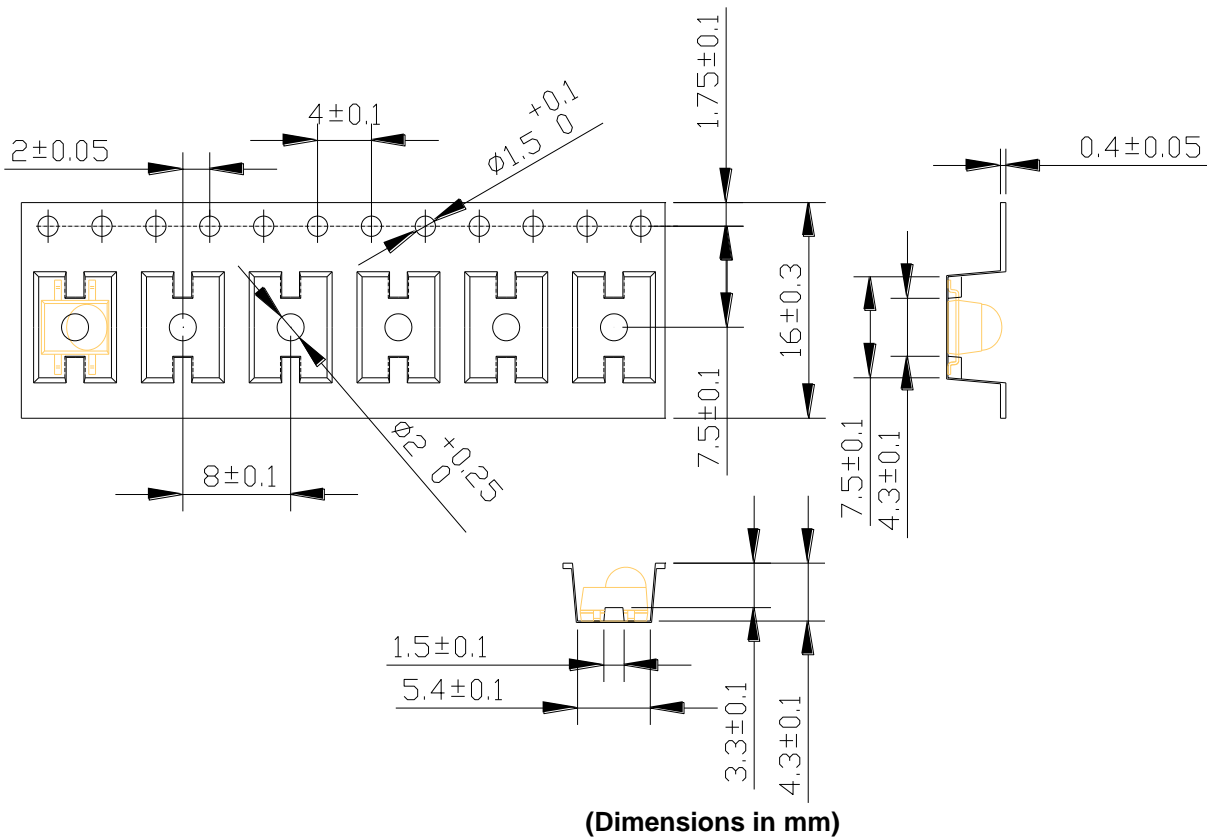

Packing Quantity

1000 pcs / Reel
5 Reel / Carton

Label format

Pb EVERLIGHT

CPN:
P/N: 30XXXXXXXXX

RoHS

IRM-XXXX/TRX

QTY: 2000 CAT:
 HUE:
 REF:

LOT NO:

MADE IN CHINA

Caution
This bag contains
MOISTURE-SENSITIVE DEVICES

LEVEL

If blank, see adjacent bar code label

1. Calculated shelf life in sealed bag: 12 months at <math><40^{\circ}\text{C}</math> and <math><90\%</math> relative humidity (RH)
2. Peak package body temperature: _____ $^{\circ}\text{C}$
If blank, see adjacent bar code label
3. After bag is opened, devices that will be subjected to reflow solder or other high temperature process must
 - a) Mounted within: _____ hours of factory conditions
If blank, see adjacent bar code label
 - b) Stored at <math><10\%</math> RH
4. Devices require bake, before mounting, if:
 - a) Humidity Indicator Card is >10% when read at $23 \pm 5^{\circ}\text{C}$
 - b) 3a or 3b not met
5. If baking is required, devices may be baked for 48 hours at $125 \pm 5^{\circ}\text{C}$

Note: If device containers cannot be subjected to high temperature or shorter bake times are desired, reference IPC/JEDEC J-STD-033 for bake procedure

Bag Seal Date: _____
If blank, see adjacent bar code label

Note: Level and body temperature defined by IPC/JEDEC J-STD-020

Moisture Classification-storage and used condition label

Recommended method of storage

The following are general recommendations for moisture sensitive level (MSL) 4 storage and use:

1. Shelf life in sealed bag from the bag seal date: 12 months at $< 40\text{ }^{\circ}\text{C}$ and $< 90\%$ relative humidity (RH)
2. After bag is opened, devices that will be subjected to reflow solder or other high temperature process must be mounted within 72 hours of factory conditions $< 30\text{ }^{\circ}\text{C}/60\%\text{RH}$.
3. If the moisture absorbent material (silica gel) has faded away or the IRM has exceeded the storage time. Baking treatment is required, refer to IPC/JEDEC J-STD-033 for bake procedure or recommend the conditions: $60\pm 5\text{ }^{\circ}\text{C}$ for 96 hours.

ESD Precaution

Proper storage and handling procedures should be followed to prevent ESD damage to the devices especially when they are removed from the Anti-static bag. Electro-Static Sensitive Devices warning labels are on the packing.

Solder Reflow Temperature Profile

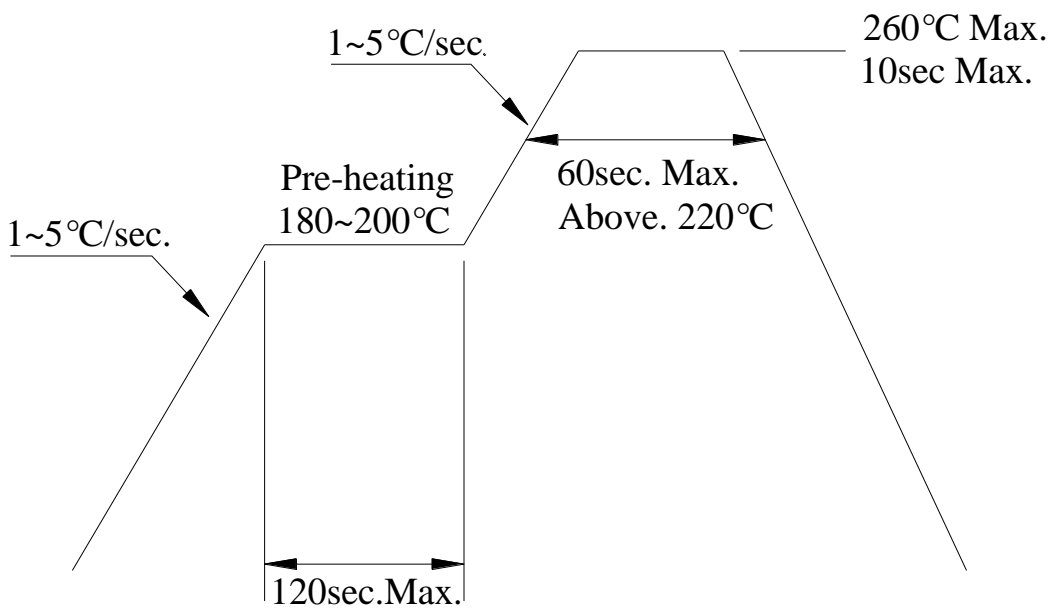

Note:

1. Reflow soldering should not be done more than two times.
2. When soldering, do not put stress on the IRM device during heating.
3. After soldering, do not warp the circuit board.

DISCLAIMER

1. The materials are not changed without PCN for the customer.
2. When using this product, please observe the absolute maximum ratings and the instructions for use outlined in these specification sheets. EVERLIGHT assumes no responsibility for any damage resulting from use of the product which does not comply with the absolute maximum ratings and the instructions included in these specification sheets.
3. These specification sheets include materials protected under copyright of EVERLIGHT. Reproduction in any form is prohibited without the specific consent of EVERLIGHT.

Application Restrictions

4. Above specification may be changed without notice. EVERLIGHT will reserve authority on material change for above specification.
5. When using this product, please observe the absolute maximum ratings and the instructions for use outlined in these specification sheets. EVERLIGHT assumes no responsibility for any damage resulting from use of the product which does not comply with the absolute maximum ratings and the instructions included in these specification sheets.
6. These specification sheets include materials protected under copyright of EVERLIGHT. Reproduction in any form is prohibited without the specific consent of EVERLIGHT.